



Operator's Manual and Spare Parts



Rotary Hoe MODEL -XEOS XE SERIES

CONGRATULATION

Dear Customer,

With the decision to buy a TIGER agriculture machinery, you have made a wise choice. You will immediately note the ruggedness and dependability of this machine. This manual contains information on operation and maintenance of the machine. Observing all advice will guarantee a regular working order a longer machine life and savings on machine maintenance. To avoid injuries and to get the best results from your machine, read it carefully and keep it around for future reference.

GANESH AGRO EQUIPMENTS is always at your disposal to give you quick and efficient assistance to maintain the correct operation and maximum output of this machine.

With best Wishes

**GANESH AGRO EQUIPMENTS
North Gujarat
India**

Disclaimer :

GANESH AGRO EQUIPMENTS reserves the right to alter the machine without prior notice and without immediately updating this manual. The Rotary Hoe is designed exclusively for working the soil. Failure to use this machine other than as described in this manual could result in human injury and / or equipment damage and / or equipment damage. GANESH AGRO EQUIPMENTS declines any responsibility for damage or injury caused by, directly or indirectly, from breakage of the machine or parts thereof, as well as those caused by proper or improper use of the same.

INDEX

1	Introduction	
	1.1) Identifying the machine.....	4
	1.2) Technical Specification of Rotary Hoe	5
2	How to work Safety and prevent accidents	6
	1) Recognize Safety Information.....	6
	2.2) Understand Signal.....	6
	2.3) Follow GENERAL Safety Instructions.....	7
	2.4) Follow EQUIPMENT Safety Instructions.....	8
	2.5) Follow OPERATING Safety Instructions.....	9
	2.6) Follow TRANSPORTING Safety Instructions.....	10
	2.7) Follow MAINTENANCE Safety Instructions.....	11
	2.8) Follow STORAGE Safety Instructions.....	11
	2.4) Safety Labels.....	12
3	Rotary Hoe Setup	15
4	Tractor Rotary Hoe Setup	16
5	Attaching and Detaching of Machine to tractor	17
	5.1) Lower Linkage positioning.....	17
	5.2) Connecting to the tractor.....	18
	5.3) PTO Shaft Installation.....	19
	5.4) Begin work.....	21
	I) Operating Instructions.....	22
	II) Adjustments.....	23
	- Lower Linkage Point Adjustment.....	23
	- Friction Clutch Adjustment.....	23
	- Skids Adjustment.....	24
	- Tail Flap Adjustment.....	25
	5.5) Stopping and Disconnection.....	26
	5.6) Transporting.....	27
	5.7) Parking.....	27
6	Maintenance	28
	6.1) Recommended Lubrication.....	28
	- GEAR BOX LUBRICATION.....	28
	- SIDE CASE LUBRICATION.....	29
	- BEARING HOUSE LUBRICATION.....	30
	- PROPELLER SHAFT.....	30
	6.2) Blade Replacement.....	31
	6.3) Routine Maintenance.....	33
	- Prior to Operation.....	33
	- First two hours.....	33
	- Daily Maintenance (minimum of every 8 hours).....	33
	- Weekly Maintenance.....	33
	- After every 250 hours of work.....	33
	6.4) Propeller Shaft.....	33
7	Troubleshooting and Solutions	35
8	Torque Table	37
9	Parts Identification with Code	38
10	Warranty	49

SECTION – 1 INTRODUCTION

GANESH AGRO EQUIPMENTS welcomes you to the growing family of new product owners. The Rotary Hoe is a machine which has been designed for preparing the soil in nurseries, vineyards, orchards and open filed. The machine uses a chain of gear transmission to transmit power from the tractor PTO to a rotor assembly.

Each rotor flange can hold 4 to 6 blades that act directly on the soil to uniformly break it up. The working depth is set by means of the lateral skids. This guarantees a uniform working depth and levelling of the ground.

The standard machine is equipped as follows:

- Rear hood with lateral skids to regulate the working depth
- PTO shaft and relative instruction manual
- Spanner









1.1 Identifying the machine

There is identifying registration plate fixed on the machine (fig.1).This plate gives you the following information.

- Manufacturers' name
- Standard Weight
- Model
- Year of Manufacturing
- Batch Number

		GANESH AGRO EQUIPMENTS	
		Kalol-Mehsana Highway, Vadpura, Gujarat, INDIA 382705	
		Phone : +91 2764 273442 / 267446	
		Customer Care Number : 1800 1200 313	
		Email : info@ganeshraj.com	
		Web : www.ganeshraj.com	
Model :	<input type="text"/>	Weight (Kg.) :	<input type="text"/>
Sr. No. :	<input type="text"/>	Year of Mfg. :	<input type="text"/>
MADE IN INDIA			

1.2 Technical Specification of Rotary Hoe

MODEL								
XE36	GEAR	1020 Mm 40 Inch	902 Mm 36 Inch	15-28 Hp 11-19 Kw	155 Kg 342 Lbs	L/C	24	4
XE42	GEAR	1195 Mm 47 Inch	1077 Mm 42 Inch	20-30 Hp 15-22 Kw	170 Kg 375 Lbs	L/C	30	5
XE48	GEAR	1400 Mm 55 Inch	1282 Mm 50 Inch	20-35 Hp 15-26 Kw	185 Kg 408 Lbs	L/C	36	6
XE60	GEAR	1643 Mm 65 Inch	1523 Mm 60 Inch	25-40 Hp 19-30 Kw	205 Kg 452 Lbs	L/C	42	7

(A) (B)

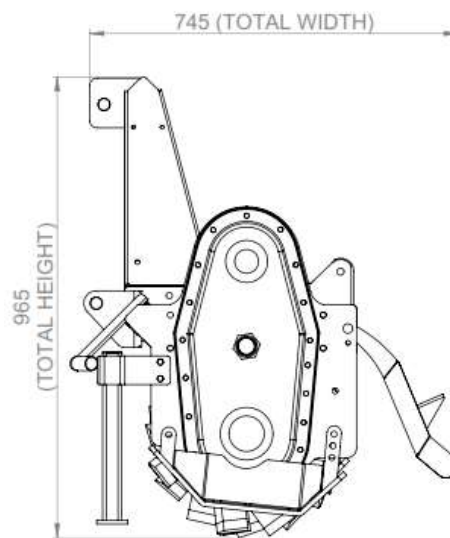

(A)

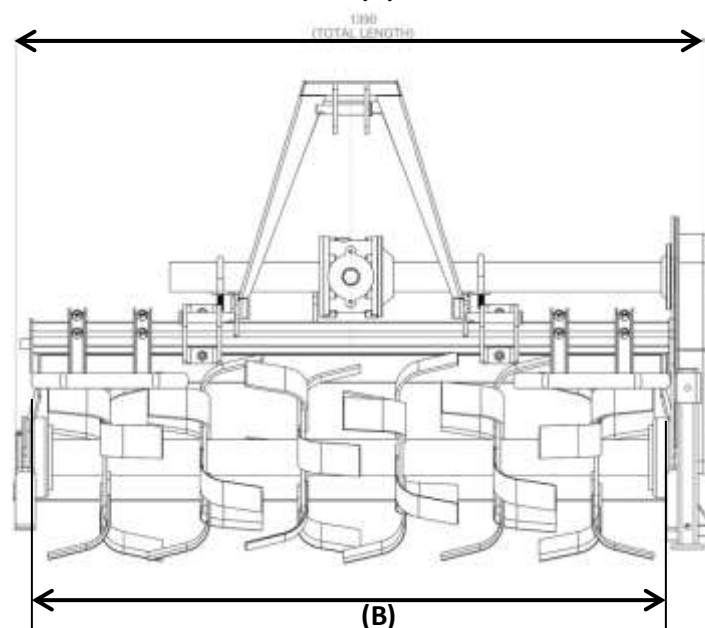

(B)

SECTION – 2 HOW TO WORK SAFETY AND PREVENT ACCIDENTS

Safety is a primary concern in the design and manufacturing of our products. Unfortunately, our efforts to provide safe equipment can be wiped out by a single careless act of an operator.

In addition to the design and configuration of equipment, hazard control and accident prevention are dependent upon the awareness, concern, prudence and proper training of personnel involved in the operation, transport, maintenance and storage of equipment.

It has been said, “The best safety device is an informed, careful operator.” We ask you to be that kind of operator.

2.1 Recognize Safety Information



This is a safety-alert symbol. A careful reading of this manual will allow you to understand this new piece of equipment and will provide you all the tools needed to use it safely.

Proper maintenance and knowledge of the safety rules of use will ensure the best performance and extend the life of the machine.

Follow recommended and safe operating practices.

2.2 Understand Signal

Safety alert symbol is used in conjunction with following Signal words, according to the degree of possible injuries that may result operating the implement;

	DANGER identifies the most serious hazards, if not avoided, will result in death or serious injury.
	WARNING indicates a potentially hazardous situation that, if not avoided, could result in death or serious injury, and includes hazards that are exposed when guards are removed. It may also be used to alert against unsafe practices.
	CAUTION indicates a potentially hazardous situation that, if not avoided, may result in minor or moderate injury. It may also be used to alert against unsafe practices.
	IMPORTANT indicates instruction or procedure that, if not observed, can cause damage to equipment or environment.
	NOTE indicates helpful information.

READ – UNDERSTAND – FOLLOW, the safety messages following the Safety Alert symbol and Signal Words. Failure to comply with safety messages could result in serious bodily injury or death.

2.3 Follow GENERAL Safety Instructions



The machine must be used only by authorised and well-trained operators. The operators must have read and understood the instructions of this manual. They must make adequate preparation for the proper use of the machine and in case of doubt about the use of the machine and/or the interpretation of this manual the operator must contact the Manufacturer or the Dealer.



The manual must always remain with the machine. In case of loss or damage, request a new copy to the manufacturer or your Dealer.



Follow strictly the rules prescribed by the safety pictograms applied to the machine.



Be sure that all safety pictograms are legible. If pictograms are worn, they be replaced with others obtained from the Manufacturer and placed in the position indicated by this manual.



Before using the machine, make sure that all safety devices are installed and in good working conditions. In case of damages of shields of shields, replace them immediately.



Is forbidden to remove or alter safety devices.



Before starting and during operation of the implement make sure there are no people or animals in the area of operation: the machine can project material from the back, with risks of serious injury or death.



Pay maximum attention to avoid any accidental contact with rotating parts of the machine.



During operation, adjustment, maintenance, repairing or transportation of the machine, the operator must always use appropriate Personal Protective Equipment (PPE)



Do not operate the implement while wearing loose-fitting clothing that can give rise to entanglement in parts of the machine.



Do not operate the implement when tired, not in good condition or under the influence of alcohol or drugs.



If the use of the machine is required at night or in conditions of reduced visibility, use the lighting system of the tractor and possibly an auxiliary lighting system.

2.4 Follow EQUIPMENT Safety Instructions



Use the implement for its intended purpose only. Improper use can damage the implement and cause serious injury to persons, animals, or death.



The machine should be used by a single operator driving the tractor.



Any unauthorised modification of the machine may cause problems in safety and relieves the manufacturer from any liability for damages or injuries that may result in operators, third parties, and objects.



Before using the machine, familiarise yourself with its controls and its working capacity.



Do not leave the implement unattended with tractor engine running.



Do not operate implement on unstable (muddy or sandy) or rocky ground.



Keep the machine clean from debris and foreign objects which may damage functioning or cause injury.



Do not use the machine if the category of the connecting pins of the Rotary Hoe does not match that of the tractor hitch system.



Do not use the machine with missing bolts, screws, pins or safety pins.



Never use the machine to transport or lift people, animals or objects.



Make certain that at least 20 % of the total weight (tractor, implement and ballast) is on the front axle of the tractor to ensure stability. Add front ballast if required.



Before engaging the tractor PTO, make sure the tractor PTO speed is set as required for this implement (540 RPM). Do not over speed PTO or machine breakage may result.



Do not operate the implement if the driveshaft is damaged. The driveshaft could break during operation, causing serious injury or death. Remove the driveshaft and repair or replace it before continuing operation.

2.5 Follow OPERATING Safety Instructions



Before using the machine, be sure to have cleared the operating area from obstacles (stones, branches, debris, etc). Mark all the obstacles that cannot be removed (e.g., by means flags).



Never engage the tractor PTO in the presence of people close to the driveshaft. The body, hair or clothing of a person can get caught in rotating parts, causing serious injury or death.



Before engaging the PTO and during all operations, make sure that no person or animal is in the immediate area of action of the machine. Never use the Rotary Hoe if people are in his working area.



Its forbidden to stand near an implement like this when parts are moving.



The operator must operate implement (lifting/lowering) only from the driving seat of the tractor. Do not perform lifting manoeuvres on the side or behind the tractor.



Before making changes in direction, turns or going in reverse, slightly lift the implement off the ground after disengaging the power take-off, to avoid damage to the machine.



In the presence of step or slopes (greater than 15 degree) the action of this machine may cause instability of the tractor with a risk of tipping off which a consequence may be serious injury or death hazard. Consult the manual for the tractor to determine the maximum slope that the tractor can handle.



Always disengage the PTO before raising the implement and never engage the PTO with the implement raised. The machine might throw objects at high speed, causing serious injury or death.



Never leave the driver's seat when the tractor is turned on. Before leaving the tractor, lower the Rotary Hoe to the ground, disengage the PTO, insert the parking brake, stop the engine and remove the key from the control panel.



The PTO shield of the tractor and implement side, the driveshaft shielding and the driveshaft retaining chains must be properly installed and in good condition, to avoid the risk of entanglement with serious injury or death.



Before engaging the PTO of the tractor, always make sure that the drive shaft is mounted in the correct direction, and that its clamping elements are properly connected both to tractors side and to Rotary

hoe side.



Stop operating immediately if blades strike a foreign object. Repair all damage and make certain rotor and blades are in good condition before resuming operation.



Always disengage the tractor PTO when the driveshaft exceed an angle of 10 degrees up or down while operating. An excessive angle with driveshaft rotating can break the driveshaft and cause flying projectiles.



Avoid clutch's overheating caused by too long or frequent slipping of the clutch, since it can damage the clutch components. Before checking slip clutch, make sure it has cooled. Clutch could be extremely hot and cause a severe burn.



Prolonged use of the implement can cause overheating of the gearbox. Do not touch the gearbox during use and immediately after, it could be extremely hot and cause a severe burn.



All repairs to the implement must be performed by qualified and trained operators, with the tractor engine OFF; the PTO disengaged, the implement lowered to the ground or on secured stands, the ignition key OFF and the parking brake set.

2.6 Follow TRANSPORTING Safety Instructions



Before transporting, determine the stopping characteristics of the tractor and implement.



Transport only at speeds where you can maintain control of the equipment.



When driving on roads, the implement must be in transport position adequately raised from the road surface, with tractor lifting hydraulics locked so that the Rotary hoe cannot be lowered accidentally.



The implement may be wider than the tractor. Pay attention to transporting for people, animals, buildings/sheds and/or other obstacles.



When turning, use extreme care and reduce tractor speed.



Do not operate the tractor with weak or faulty brakes or worn tires.



Always use tractor lighting system and auxiliary lighting system for an adequate warning to operators of other vehicles, especially when transporting at night or in conditions of reduced visibility.



In the case of lifting this implement, make sure that any lifting device is suitable to operate safely, and use only the lifting points prescribed on Rotary Hoe.

2.7 Follow MAINTENANCE Safety Instructions



All maintenance and repair operations must be performed by qualified and trained operators, with the tractor engine off; the PTO disengaged, the Rotary Hoe lowered to the ground or on security stands, the ignition key off and the parking brake set.



Perform repairs and replacements part should only be original spare parts provided by the manufacturer, importer or your dealer.



Perform maintenance operations using appropriate Personal Protective Equipment (protective eyeglasses, har hat, hearing protection, safety shoes, overall and work gloves, filter mask).



Before any maintenance operation, make sure that the parts which become hot during use (friction clutch, gearbox etc.) have cooled.



Do not perform repairs that you do not know. Always follow the manual instructions and in case of doubt contact the Manufacturer or your dealer.



Do not swallow fuels or lubricants. In case of accidental contact with eyes, rinse well with water and consult a doctor.

2.8 Follow STORAGE Safety Instructions



Never leave the tractor unattended with the implement in the lifted position. Accidental operation of lifting lever or a hydraulic failure may cause a sudden drop in the unit which result in injury or death.



Following the operation, or before unhooking the implement, stop the tractor, set the brakes, disengage the PTO, lower the attached implement to the ground, shut off the engine, remove the ignition key and wait for all moving parts to stop.



Make sure all parked machines are on a hard, level surface and engage all safety devices.



Place support blocks under implement as needed to prevent the unit from tipping over onto a child and/or an adult. An implement that tips over can result in injury or death.









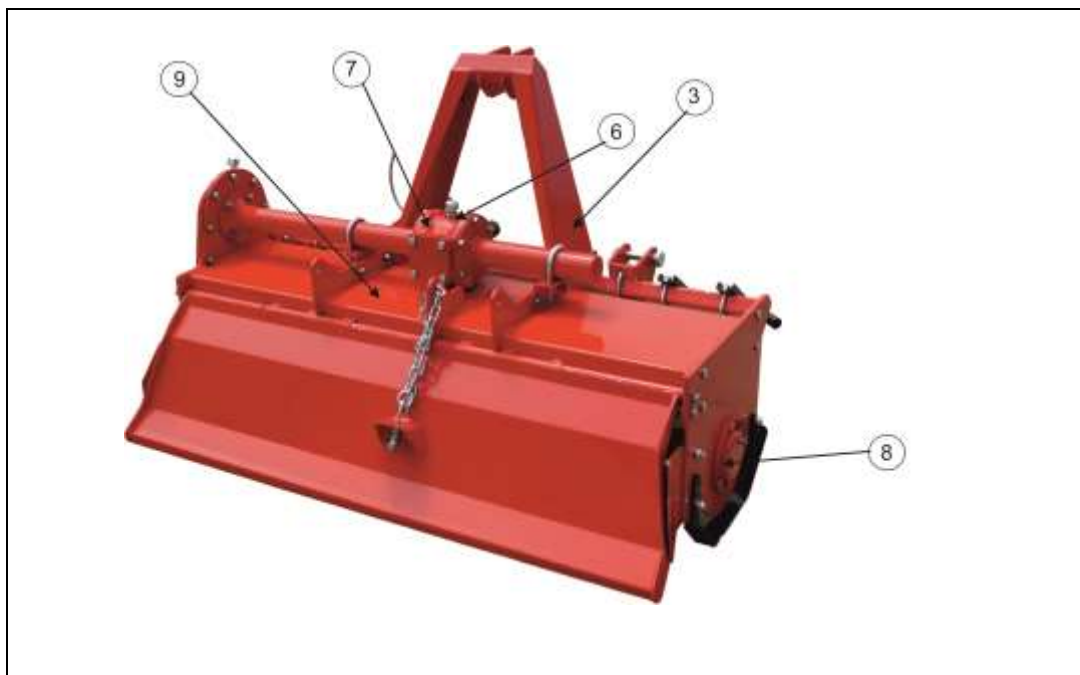

WARNING

Store the unit in an area away from human activity.

2.9 Safety Labels

The following safety labels are posted on the machine. Read them carefully and memorize their meanings. Always replace them if they are detached or damaged taking care of putting them as indicated fig.7



1		<p>Disengage the PTO, turn OFF the tractor engine, remove the key and ensure that all rotating parts have stopped before approaching the implement. Read the operator's manual before performing any maintenance operation. Thrown or flying objects hazard.</p>
2		<p>Safety Equipment</p>
3		<p>Crushing hazards & Thrown or Flying objects hazards.</p>
4		<p>Operate only with 540 rpm PTO</p>
5		<p>Rotating Gears</p>
6		<p>Oil filling point</p>
7		<p>Lifting point</p>

8	 A yellow rectangular symbol with a black border. Inside, there is a black outline of a grease gun nozzle. Below the nozzle, the word "GREASE" is written in black capital letters. At the bottom of the symbol, the number "5,1000" is written in a smaller font.	Grease filling point
9	 A yellow rectangular symbol with a black border, divided into two sections. The left section contains a black triangle with a hand being crushed between two gears. The right section contains a black circular symbol with a hand being crushed between two gears, with the word "STOP" written in red capital letters below it.	Hand Hazard

SECTION – 3 ROTARY HOE SET UP

Preparing the machine for work must be done with the PTO disengaged the machine on the ground and tractor OFF and blocked.

Before starting the machine, the SETUP includes following inspection at machine level:

- Check the Rotary hoe is suited to the tractor horsepower.
- Check oil and grease lubrication point as per Manufacturer's requirement for relevant machine.
- Guards are properly installed and all parts subject to wear and tear are in good working condition.
- Safety decals are on the machine and clean.
- Bolts and nuts are tightened.

SECTION – 4 TRACTOR SETUP

4.1 Use your Tractor Operator’s Manual

- Always refer to your Tractor Operator’s Manual for specific detailed information regarding operation of your tractor.
- Following tractor related information uses tractors to illustrate preparation, attachment and operational procedures.
- Use your tractor OM for detailed information, as procedures will vary by equipment.

4.2 Tractor Stability and Lifting Capacity Check

When machine is jointed to tractor, It becomes an integral part of it. Attached equipment’s weight is closely related with road position and stability of tractor. In normal conditions, it is assumed that 20% of tractor weight is carried by front axle. In this case, attached equipment’s weight should not be greater than 30% of tractor weight. This factor can be summarized in following formulas:

$$M \times s \leq 0,2 \times T \times i + Z \times (d + i)$$

$$Z \geq \frac{(M \times s) - (0,2 \times T \times i)}{(d + i)}$$

$$M \leq 0,3 \times T$$

Symbol	Unit	Description
M	kg	Mass weighing on arms of hoist with full load
T	kg	Mass of tractor
Z	kg	Total mass of ballast
i	m	Tractor wheelbase that is horizontal distance between axles of tractor
d	m	Horizontal distance between centre of gravity of ballast and front of axle of tractor
s	m	Horizontal distance between centre gravity of operating machine and rear axle of tractor

When machine is attached to tractor, front weights should put through above mentioned formula. These weights should be calculated according to capacity of tractor’s lifting weight and packing.

SECTION – 5 ATTACHING AND DETACHING TO THE TRACTOR

The implement is delivered fully assembled and equipped with a driveshaft with friction clutch (clutch discs) and related operating manual.

When the machine is delivered, check that there is no damage to the implement and driveshaft. In case of damage or missing parts immediately notify the manufacturer, importer or your dealer.

5.1 Lower Linkage Positioning

The XEOS-Series Rotary Hoes are designed to be mounted on tractors equipped with :

- 3-point Hitch Category I (ISO 730 standard);
- Quick Hitch Category I (ASABE Standard).

The position of the lower hitches must be adjusted accordingly.

If the tractor is equipped with a Quick Hitch Category I (ASABE Standard), verify that the lower linkage point shows the pins oriented up (see figure), so that the distance between upper and the lower pins is 15" (381 mm), as required from the standard.

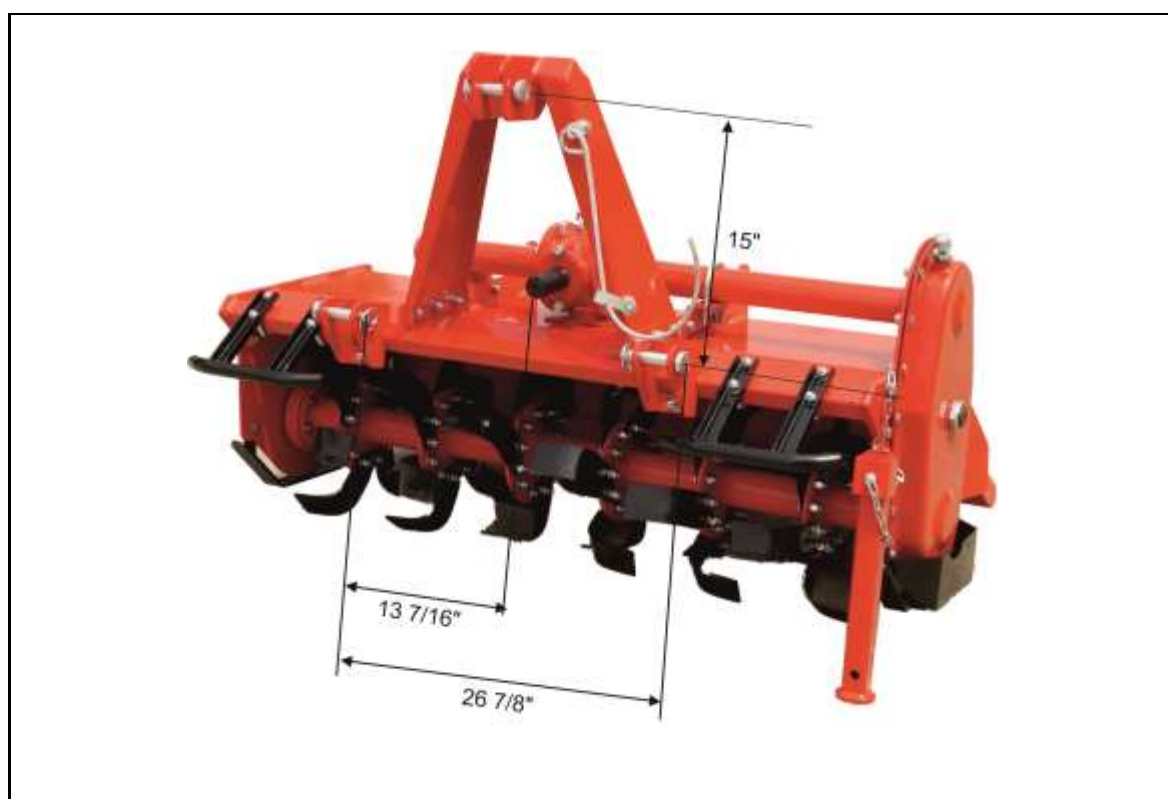

If this does not occur, proceed as follows for each of the two linkage points:

- Remove the U-Bolt and the linkage point from the square tube;
- Invert the linkage point orientation and reposition it on the square tube at distance of 13 7/16" from the centre of Rotary Hoe PTO. At the end of the operation the lower linkage point should be positioned symmetrically to Rotary Hoe PTO, at distance of 26 7/8" (683 mm);
- Re-tighten the U-bolt, referring to the tightening table of this manual.



If the tractor is equipped with a 3-point Hitch Category I (ISO 730 standard), verify that the lower linkage point shows the pins oriented down (opposite than figure above), so that the distance between upper and the lower pins is 18" (460 mm approx.), as required from the standard.

If this not occurs, proceed as follows for each of the two linkage points:

- Remove the U-bolt and the linkage point from the square tube;
- Invert the linkage point orientation and reposition it on the square tube at distance of 13 7/16" from the centre of Rotary Hoe PTO. At the end of the operation the lower linkage points should be positioned symmetrically to the Rotary Hoe PTO, at distance of 26 7/8" (863 mm)
- Re-tighten the U-Bolt, referring to the tightening table of this manual.
- Remove from upper position and fit the lower pins bushings provided for coupling with Quick Hitch, through the extraction of the pins. Replace the pins when finished. Store the bushings for possible future use.

5.2 Connecting to the Tractor

Implement can be attached to the suitable category tractor. Follow below procedure for attaching the implement to the tractor.

	<ul style="list-style-type: none"> • Disengage PTO Drive • Trained person is required to attach and detach from the tractor. Else may cause major injury to operator and severe damage to implement and tractor.
	<ul style="list-style-type: none"> • Implement should always be park on level ground for attaching and detaching to tractor safely and easily. • Before attaching implement to the tractor, check for any accessories fitted on tractor like drawbar, swinging drawbar, automatic hitch etc. for any hindrance, restriction, proper functioning and free up and movement of equipment. If required remove accessories before attaching equipment.

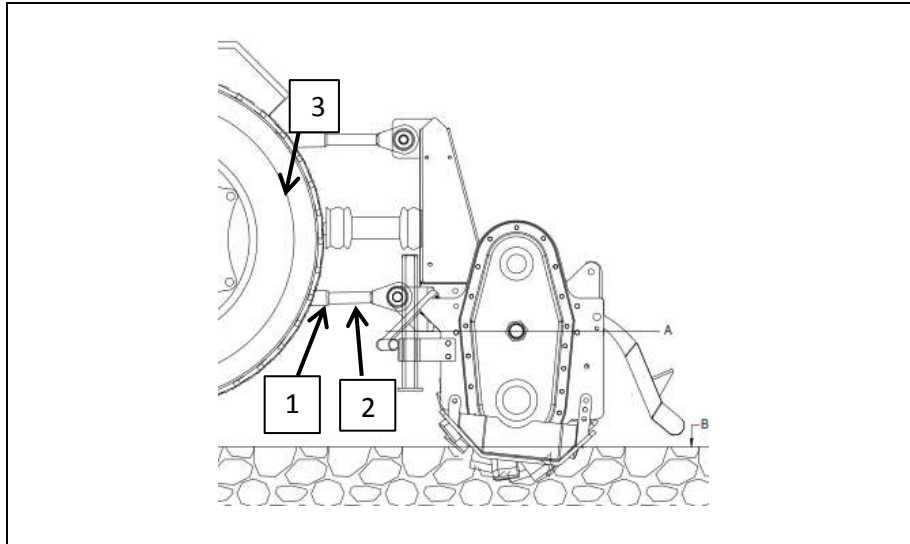

When using tractors with multi-speed PTO, be certain that PTO is set for prescribed RPM.

1. Bring the tractor back and insert LH lower link (1) of the tractor to the corresponding hitch pin of the equipment and lock it with the help of latch pin (Fig.1)
2. Similarly attach RH lower link (2) of the tractor to the corresponding hitch pin of the equipment. If required adjust height of lower link with the help of adjustable lift rod.
3. Attach top link (3) of tractor to top hitch point of the equipment. Adjust length of top link if required to reach and align to the required hole on the top hitch point.

5.3 PTO Shaft Installation

IMPORTANT	The universal propeller shaft supplied, with the machine, is of standard length. Therefore it might be necessary to adapt the universal drive shaft
------------------	---

IMPORTANT	<ul style="list-style-type: none"> • The propeller shaft must have protective covers. • The propeller shaft without covers should never be used. • The tractor may not be running during the mounting and dismounting of the shaft. • No other persons should be around the propeller shaft during processes with the shaft.
------------------	--

Make sure the PTO shaft length is compatible with the different working positions of the implement. If the PTO shaft is too long it might bend and damage may occur to the tractor or implement.

Place the tractor and the implement on a flat surface. Attach the 3 point linkage of the tractor (see the section – 5.2 connecting to the tractors)

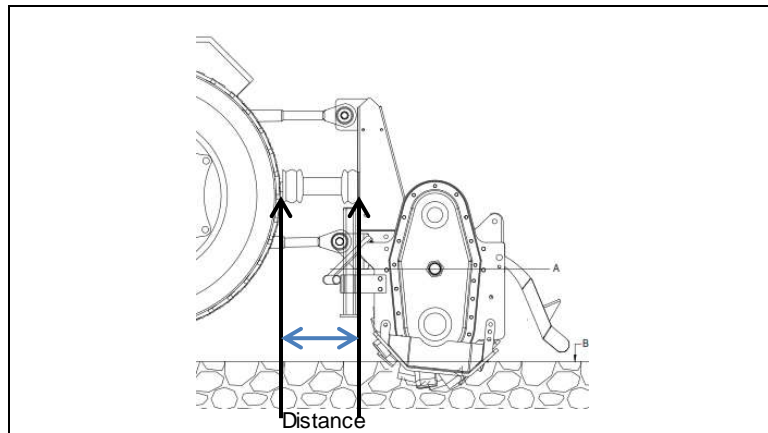

Find the length between the groove of PTO output on the tractor, and the PTO input on the implement when the implement and tractor is in horizontal position.

Before operating the implement ensure that the size of the propeller shaft is adequate. The PTO shaft supplied with the machine comes in a standard length. Therefore it may need to be shortened depending on your tractor and implement.

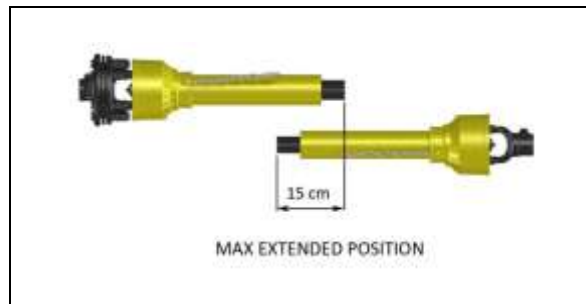

When the propeller shaft is at its minimum length, there must be at least a 4 cm of distance between the ends of each transmission tube and the yoke side.



When the propeller shaft is at maximum operational extension, there must be an overlap between the tubes profiles of 15 cm at least.

IMPORTANT	<ul style="list-style-type: none"> Before operating the implement the first time, make sure that the propeller shaft is lubricated in accordance with how indicated in the instruction booklet.
------------------	--

	<ul style="list-style-type: none"> • Before operating the implement the first time, and after long periods of inactivity, make sure that the propeller shaft clutch has not seized. It may be necessary to 'slip' the clutch and reset due to possible oxidation of the components that may compromise the correct slipping during the usage. • Always engage the tractor PTO at low rpm to minimise the effect of the peak torque on the propeller shaft and the machine.
--	--

5.4 Begin work

Before the start-up and before each use, perform the following pre-operation inspections and service of the implement;

- Check that the implement has no damaged functional parts and has all mechanical parts are good condition. Repair and / or replace the damage parts;
- Check that the implement has no missing parts (pins, safety pins, plug oil so on). Restore the missing parts;
- Check that all guards and safety devices have no damages and are properly positioned. Repair and / or replace the damaged shields, restore the correct position;
- Verify that the PTO driveshaft is properly installed (see section : connecting to the tractor);
- Check that the propeller shaft clutch is in good condition, and that its components are not subject to "sticking" (see section: Maintenance – Propeller shaft);
- Check the presence of lubricant in all greasing points of the implement (propeller shaft, supports so on) (see section : Maintenance / Propeller shaft and Maintenance / Support rotor);
- Check for oil leaks from the gearbox or the transmission side cover. Identify the reason of loss then repair and / or replace the damaged components;
- Check the correct oil level in the gearbox and in transmission side box (see section : Maintenance)
- Check that blades are not excessively worn and the relating hardware is correctly tightened (see section : Maintenance)
- Check that all hardware (nuts, bolts etc.) are properly tightened. Refer to the tightening table in the manual for proper torque value;
- Check that all safety labels are correctly positioned, in good condition and legible. Replace any damaged labels;
- Check that there is no constraint that may prevent the movement of equipment. Remove any constraints.

Before the start-up and before each use, make the following checks on the operating area you intend to operate;

- Check that area is clear of foreign objects (rocks, branches or debris). Remove any obstacle and visibility highlight obstacles that cannot be removed (e.g., with flags);
- Make sure that in the area you intend operate there are no people or animals;
- Make sure the soil to be worked is not too grassy, muddy, sandy or rocky.

	<p>Before conducting the above inspections and service, make sure the tractor engine is OFF, all rotation parts are completely stopped, and the tractor is in park with the parking brake engaged. Make sure the implement is resting on the ground or securely blocked up and the tractor lifting hydraulics locked.</p>
---	---

Once all the checks above have been done, start the tractor and the implement as follows:

- Start the tractor and engage the tractor PTO at low rpm, making sure that the implement is NOT in the raised position but close to the ground, then increase speed engine until to 540 rpm;
- Lower the implement on the ground and simultaneously start driving the tractor forward at low speed. Subsequently, increase the ground speed depending on ground conditions;
- If the outside temperature is very cold, its recommended to engage the PTO and have the implement operate at low speed (with the tractor stationary) to warm oil and lubricate parts;
- Drive for a while operating the implement then stop the tractor to check the quality of the work performed. If you need to get off the tractor, lift the implement just out of the ground, reduce engine speed and disengage PTO, stop engine and remove the ignition key;

If the working depth and / or soil texture are not as desired, correct by adjusting the skids and/or the rear cover (see section: Adjustments)

I) Operating Instructions

During operations: OPERATE ACCORDING TO FOLLOWING INSTRUCTIONS

- Always keep the tractor engine at a speed that delivers 540 rpm to the implement. Failure to do so will affect the performance of the implement;
- Always keep a tractor speed suitable to conditions of the soil (from 2 to 10 km/h approx.) Reduce speed in the case of hard or stony soils;
- Choose a driving pattern that provides the maximum pass length and minimizes turning;
- When working in the hills, always work up and down the hill. Never work cross the hill;
- When changing directions or reversing, disengage the PTO and slightly lift the implement from the ground to avoid damage to the machine;

- Periodically check for foreign objects wrapped around the rotor shaft and remove them, after disengaging PTO, turning off tractor engine, and removing ignition key;
- If the blades strike foreign object, or in case of excessive friction clutch slippage, stop operating immediately, idle the engine speed and disengage the PTO. Wait for all rotating parts to come to a stop, then raise the implement and proceed to inspect damage, after stopped the tractor, set the parking brake, stopped engine and removed the ignition key. Repair any damage immediately, and make sure rotor and blades are in good condition before restarting operation;
- Avoid friction clutch overheating. This is caused by operating in heavy conditions or incorrectly adjusted clutch. If your clutch overheats, it can damage clutch components which will then not operate correctly which may then result in damage to your implement.

Typical problems that may occur operating the implement are described in the Troubleshooting section, together with their solutions.

II) Adjustments

	<p>All adjustment operations must be performed with the tractor engine OFF, the PTO disengaged, the implement lowered to the ground or on security stands, the parking brake set and the ignition key off.</p>
--	--

- Lower Linkage Point Adjustment

It is possible to adjust the lower linkage point position loosening the bolts 1 (see picture) and sliding the linkage point 2. Tighten the bolts after making any adjustment required.

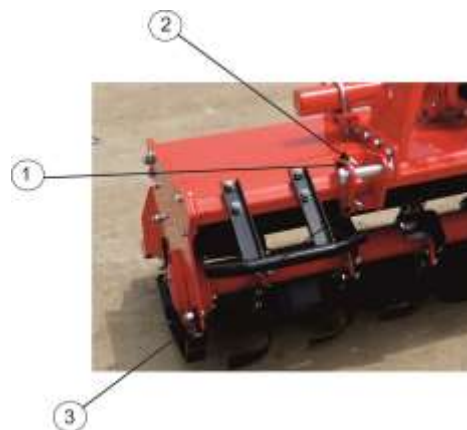

- Friction Clutch Adjustment

The PTO shaft and friction clutch are designed to transmit adequate power to the implement.

The clutch preserves the machine from overloads, through the slipping of friction discs, and limits the max torque transmissible to a calibrated value set at the factory. It is recommended, therefore,

to set the clutch and regularly adjust to avoid damages to the machine or the propeller shaft.

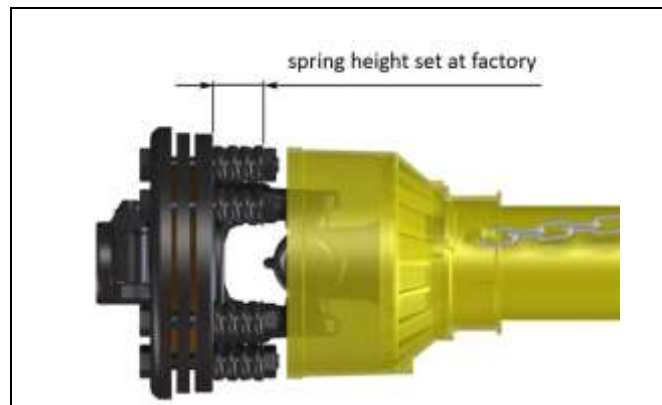

Friction clutches are designed to be adjusted. If slipping is too frequent, it means that the calibration is too low and the clutch needs to be adjusted (tightened).

In this case, the tightening of the nuts will compress the springs which will increase the drive to the implement.

On the contrary, a loosening of the nuts will decrease the drive to the implement.

IMPORTANT	<p>For details about clutch adjustment, refer to the user manual of the manufacturer of the propeller shaft installed.</p> <p>The manufacturer is not liable for damages resulting from a wrong modification of the clutch calibration.</p>
------------------	---

NOTE	<p>Excessive tightening of the springs can prevent the clutch from slipping and then there is no protection for the machine from overload.</p> <p>Make sure that the height of all the compressed springs is equal to prevent the clutch malfunctioning.</p>
-------------	--

- Skids Adjustment

The working depth of the implement is determined by the position of the side skids. It may be increased by raising the skids and decreased by lowering them. It is important that both skids are adjusted to the same height.

To adjust the working depth, perform the following steps;

- Lift the machine, put it safely on security stands, then switch the tractor engine off, disengage PTO, set the parking brake and off the ignition key;
- Loosen the bolt in the front of the skid (bolt 1 – see picture);
- Unscrew and remove the bolt on the rear of the skid (bolt 2 – see picture);
- Adjust the height of the skid through the holes, as desired;
- Reinstall the bolt 2 (refer to the tightening table of this manual for proper torque values);
- Tighten the bolt 1 (refer to the tightening table of this manual for proper torque value);

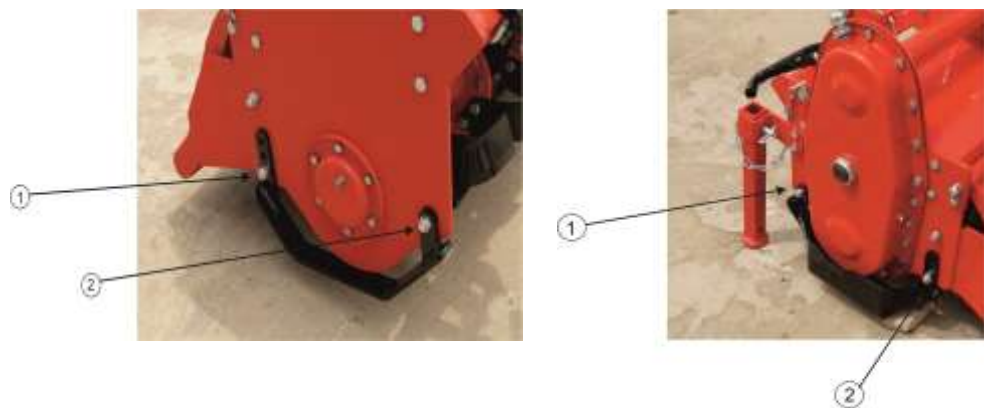

When finished, verify that both skids are at same level, and check if the front of the implement is levelled to the back, when lowered to the ground. Adjust with the 3-point top link if necessary.

- Tail Flap Adjustment

The XEOS – Series Rotary Hoes are equipped with a tail flap with a chain.

The position of the tail flap is adjustable by varying the number of chain links included between distances $\frac{1}{2}$, which should remain tensioned under the weight of the flap. (i.e. links between the rear flap U-bolt 1 and the slot of the frame 2).

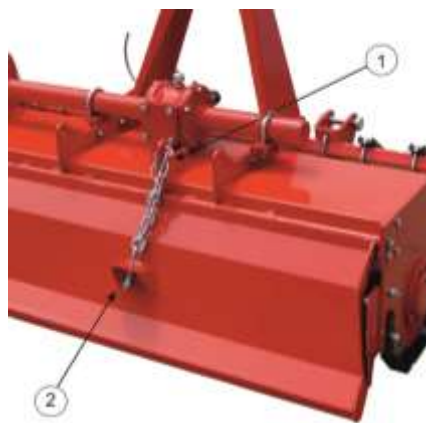

- To raise the tail flap, reduce the number of chain links in tension. This operation, together with the increase of the tractor ground speed, allows to have a coarser soil texture;
- To lower the tail flap, increase the number of chain links in tension. This operation, together with the reduction of the ground speed will result in finer soil texture.

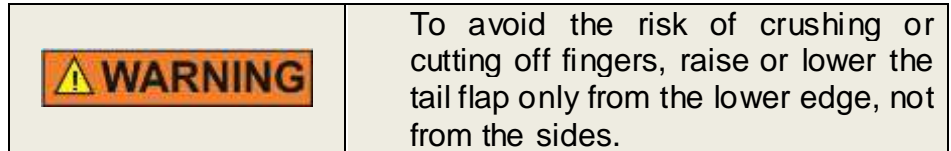

5.5 Stopping and Disconnection

To stop the implement at the end of a working session:

- Bring the tractor to a complete stop;
- Place the transmission in park or neutral;
- Reduce the engine speed, then disengage the PTO;
- Wait for stopping of all rotating parts;
- Lower the implement to the ground;
- Set the parking brake;
- Shut down the engine and remove the key before exiting the tractor;
- Do the cleaning and maintenance required to make the machine ready for later use (see Section – Maintenance)

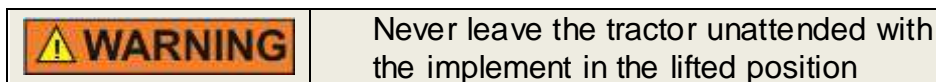

To disconnect the implement from the tractor (e.g. to make a change of implement)

- Adjust the skids to their lowest position (see section – adjustments);
- Adjust the support stand to the lowest position, through the use of relative retaining pin;
- Park the tractor on a dry and level surface;
- Reduce the engine speed, then disengage PTO;
- Wait for stopping of all rotating parts with implement lowered to the ground;
- Set the parking brake;
- Shut down the engine and remove the key before exiting the tractor;
- Place safety blocks under implement to prevent the unit from tipping over onto a child and /or an adult. An implement that tips over can result in injury or death;
- Disconnect the driveline from the tractor PTO and rest it on the provided support of the implement;
- Disconnect the top link and rear lifting arms of the tractor from the implement hitches;
- Check the implement stability. If needed, place additional safety block;

- Get on the tractor, start the engine and move away from the implement slowly;
- Make sure the implement remains stored in a protected area; to prevent those unauthorised personnel can approach it.

If you do not intend to use your implement for a long period of time, (e.g., at the end of the season), do cleaning and maintenance operations as specified in Section – MAINTENANCE and STORAGE

5.6 Transporting

To set the implement for transportation, perform the following steps:

- Idle tractor engine, disengage tractor PTO, and wait for stopping of all rotating parts;
- Lift the implement far enough off the ground to clear any objects BUT not to a point where the PTO Shaft comes in contact with the tractor or implement. A minimum gap of 2 cm should be left between the tubes and tractor and Rotary Hoe (see also Section – PTO Shaft Installation)
- Lock the tractor lifting hydraulics, turn off the engine, set the parking brake, remove ignition key and get off the tractor;
- Adjust the support stand to the highest position, through the use of the retaining pin, to prevent its possible damage during transport.

When driving on public roads operators must strictly follow local laws and traffic regulations.

	<p>When driving on public road, reduce your speed, be aware of traffic around you and proceed in such a way that faster moving vehicles may pass you safely.</p>
---	--

5.7 Parking

The following steps should be done when preparing to store the implement or unhitch it from the tractor.

- Wash and dry the machine
- Put the PTO shaft on the proper place
- Check all the moving wear parts; for damage and excessive wear, contact your dealer or qualified service technician for repair.
- Check bolts and nuts for proper tightness
- Check oil levels
- Protect and lubricate the non-painted parts.
- Make sure that the Rotary Hoe is placed on a suitable flat hard standing.

SECTION – 6 MAINTENANCE

Proper and regular maintenance ensures a long life of the implement avoids failures and saves time and repair costs.

Periodic inspections and maintenance operations described in this section must be performed by the operator in the times and terms prescribed. Failure to comply with maintenance prescriptions can compromise the functioning and duration of the machine, and consequently invalidate the warranty.

The frequency of maintenance indicated refers to normal conditions of use: it must be intensified in severe operating conditions (frequent stops and starts, prolonged winter season, etc)

Repairs, maintenance, and modifications other than those mentioned in this paragraph should NOT be performed without consulting the manufacturer or your dealer. Manufacturer, as the case, may give the authorisation to proceed with the repair together with all necessary instructions.

Wrong or inappropriate repairs or maintenance may generate abnormal operating conditions, equipment damage and generate risks for the operator.

 WARNING	For safety reasons, all maintenance operations must be performed with tractor PTO disengaged, implement stopped and completely lowered to the ground or onto support blocks, parking brake set, tractor engine shut off, and ignition key removed.
--	--

IMPORTANT	Respect the environment. Store or dispose of unused chemicals as specified by the chemical manufacturer.
------------------	--

6.1) Recommended Lubrication

The various maintenance instructions are listed below. Doing these maintenance jobs at regular intervals will not only lengthen the machine life but also reduce its maintenance costs substantially.

GEAR BOX LUBRICATION

Lubricant : SAE EP 80W90 Gear Oil

Check the oil level every 50 hours, making sure the oil mark left on the dipstick of the filling plug (top of the gearbox) is located between the two reference marks (minimum and maximum).

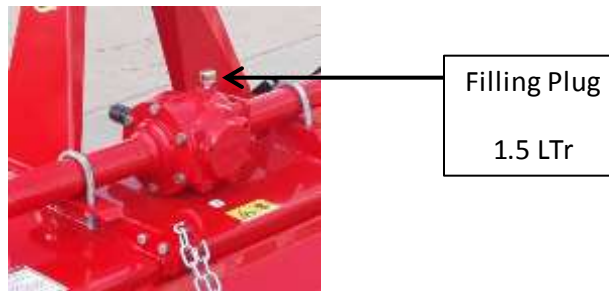

If the oil is below the minimum, fill up to restore the correct level and oil change must be performed:

- After the first 50 working hours;
- Each 500 working hours;

To carry out an oil change;

- Place a tank under the oil drain plug (bottom of the gearbox);
- Unscrew the oil drain plug and drain the oil completely into the tank;
- Retighten the drain plug;
- Unscrew the oil filling plug;
- Fill with oil to achieve the correct level (between the two reference dipstick marks);
- Retighten the filling plug;
- Dispose the discharged oil into containers for used oil.

SIDE CASE LUBRICATION

Lubricant : SAE EP 80W90 Gear Oil

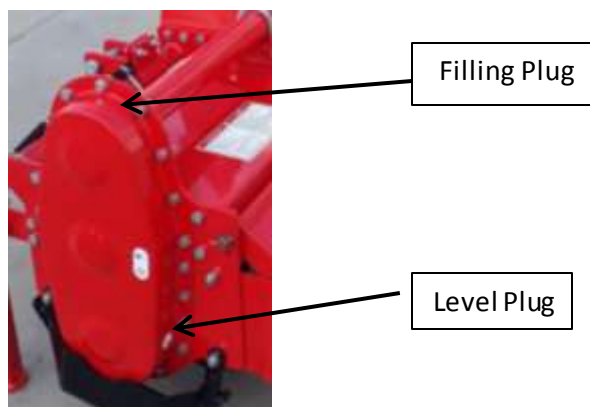

Check the oil level every 50 hours. Make sure it reaches the level plug on the transmission cover.

The oil change must be performed every 500 working hours.

To make the oil change:

- Remove the skid from the transmission side;
- Place a tank under the oil level plug;
- Unscrew the oil level plug and drain the oil completely into the tank;
- Retighten the level plug;
- Unscrew the oil filling plug (top of transmission cover);
- Fill up to the correct level (until level plug);
- Retighten the filling plug;
- Replace the side skid;
- Dispose the discharged oil into containers for used oil.

BERAING HOUSE LUBRICATION

Lubricant: SAE multi-purpose lithium-type grease.

Grease the rotor hub support every eight (8) working, through a suitable grease gun.

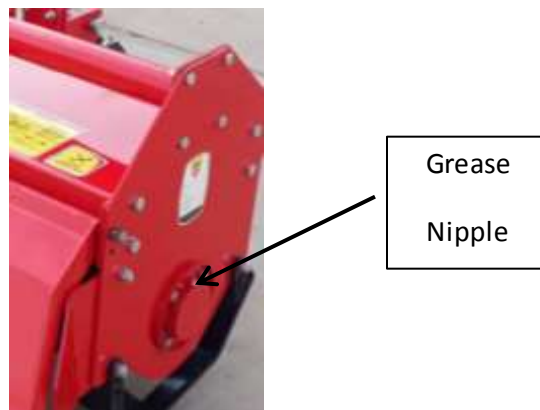

IMPORTANT	Make sure you clean the grease nipple before using a grease gun. Do not let excess grease collect on or around these parts especially when operating in sandy areas.
------------------	---

PROPELLER SHAFT MAINTENANCE

Lubricant: SAE Multi-purpose lithium-type grease

Grease crosses, sliding parts of protective shielding and driveshaft transmission tubes.

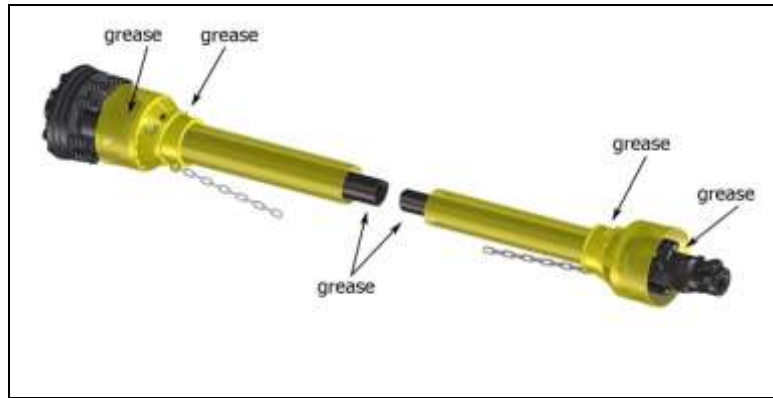

IMPORTANT	For details about maintenance and lubrication of the propeller shaft, refer to the user manual of the propeller shaft manufacturer.
------------------	---

Propeller Shaft Clutch:

Exposure of the implement and propeller shaft to environmental elements, as well as a long period of inactivity, generally results in oxidation (rust) of some clutch components. This can result in a seized clutch which will offer no protection to the implement.

To avoid a seized clutch, the operator must perform a short “run-in” of the clutch, as follows:

- Take note of the height of the compressed springs;
- Loosen the nuts of the compressed springs;
- Connect the implement to the tractor (see section : connecting to the tractor);
- Connect the propeller shaft (see section : Propeller shaft installation);
- Start the tractor and engage PTO for few seconds. You should hear and/or see the clutch slip. If not, turn off the tractor, remove the key and wait for all components are stopped before dismounting from the tractor and loosen a little more;
- Turn off the tractor, remove the key and wait for all components are stopped before dismounting from the tractor;
- Tighten the nuts (gradually) to compress springs and re-establish torque (drive) to the implement as per instruction on page.

6.2 Blade Replacement

Frequently check the wear condition of blades through visual inspection. The wear of blades is very variable depending on the type of soil.

Replacement of the blades is necessary when the operator notices increase of power absorption during operation or when the blade dimension is significantly reduced compared to the original.

The use of the machine with blades in bad condition compromises the quality of work.

Before performing replacement of the blades:

- Idle tractor engine, set the parking brake, disengage tractor PTO, and wait for all moving parts to come to a complete stop;
- Slightly raise the implement from the ground or place on safety blocks or mechanical stands;
- Lock the height control level of tractor's hydraulics;
- Turn off the tractor and remove the key.

To perform the replacement of blades:

- Remove the two bolts and washers clamping the blade to the rotor flange, then remove the blade;
- Position the new blade exactly where the worn blade was, then tighten the bolts, referring to the tightening table of this manual for proper torque values. Be sure to install the blade with cutting edge in front of the direction of rotation;
- Repeat the same procedure for all the other blades.

At the end of the replacement, make sure the blades have the right helical arrangement, as shown in the figure:

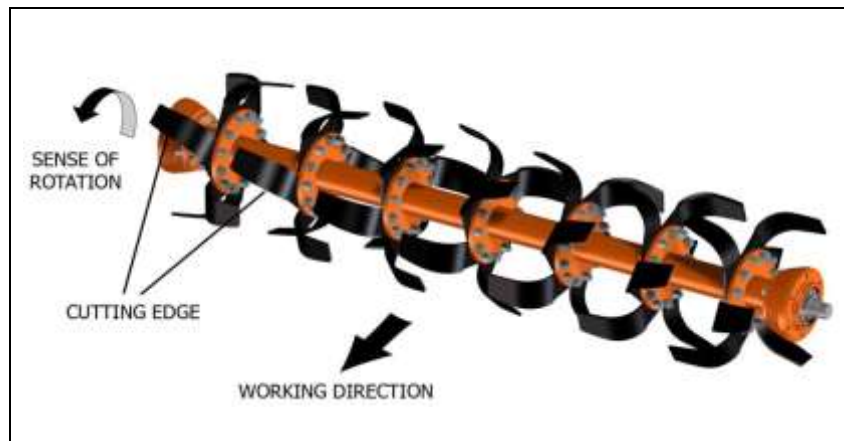

Periodically check the tightness of screws and nuts, and tighten if necessary.

IMPORTANT	Remove and install one blade at a time to ensure blades are correctly oriented when installed. Replace worn blades only with original parts.
------------------	--

 CAUTION	Remove and install one blade at a time to ensure blades are correctly oriented when installed. Replace worn blades only with original parts.
--	--

6.3 Routine Maintenance



Before oiling, maintaining or adjusting the implement, switch off the tractor engine.

The following routine maintenance procedures are recommended, to ensure the efficient and safe operation of your Rotary Hoe, as well as maximizing the work life of the machine.

- **Prior to Operation**
 1. Ensure that gearbox is adequately lubricated
- **First two hours**
 1. Check that all bolts are tightened correctly
 2. Check oil level of gear box. Top up if necessary.
- **Daily Maintenance (minimum of every 8 hours)**
 1. Separate and lubricate the drive shaft.
 2. Grease universal joints.
 3. Check the level of oil in the gearbox, and top up if necessary.
 4. Check the underside of the Rotary hoe, in particular the blades.
Replace blades if there are visible signs of damage or excessive wear.
 5. Ensure bolts are tightened securely on the blades and skids.
 6. Ensure cuttings have not built up around the gearbox or cutter unit.
- **Weekly Maintenance**
 1. Perform all steps as per daily service.
 2. Check & tightened all nuts and bolts on the rotary hoe.
 3. Clean away any residue on the rotary hoe.
 4. After approximately every 50 hours of work, check universal joints for excessive wear.
- **After every 250 hours of work**
 1. Inspect thoroughly the universal joints, and replace any worn parts.
 2. Complete full service, as per daily and weekly procedures.

6.4 Propeller Shaft

Disconnect the propeller shaft from the tractor and slide apart.

Clean and coat the inner tube of the propeller shaft with a light film of grease on daily basis or every 8 hours and then reassemble.

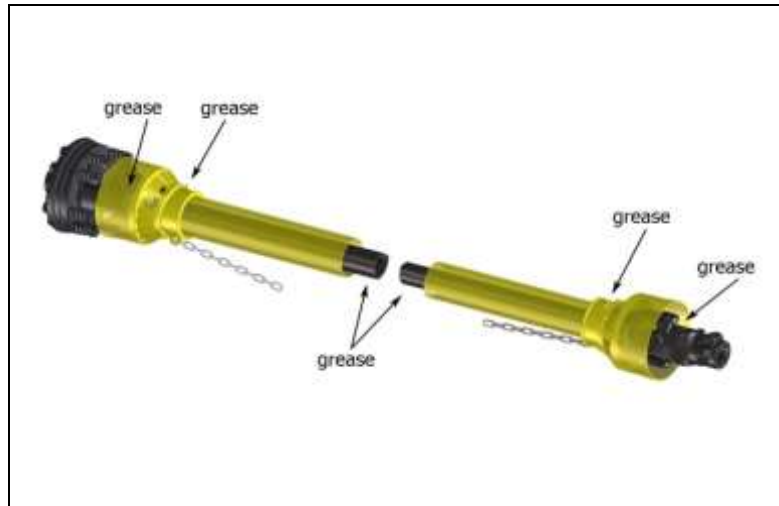

SECTION – 7 TROUBLESHOOTING

PROBLEM	CAUSE	SOLUTIONS
Gearbox/transmission case noise noticeable and constant	Low oil level. Worn gears.	Add oil to the gearbox/transmission case. Replace gears
Intermittent noise from implement	Loose blades. Gear tooth damaged.	Tighten blades hardware Replace damaged gear
Noise and/or vibration from the implement	Blades worn or damaged. Bearings damaged. The front of the implement is not levelled to the back. Rotor damaged. Hard soil.	Replace blades. Replace bearings. Adjust 3-point top link of tractor making implement PTO parallel to the ground. Repair/replace rotor Reduce ground speed
Driveline vibration	Worn driveshaft. Machine lifted too high. Debris wrapped on the rotor.	Replace driveshaft. Lower machine and readjust tractor lift stop. Remove debris.
Rotor stops turning	Slip clutch is slipping. Broken chain in chain box.	Reduce load to implement or Adjust slip clutch. Repair broken link.
Machine skip or leaves crop residue	Badly worn blades. Slip clutch is slipping. Ground speed too fast for Conditions.	Replace worn blades. Adjust slip clutch or reduce load. Reduce ground speed.
Smoke and/or hot smell from the implement	Debris wrapped around in blades and/or rotor. Low oil level in the gearbox. Slip clutch is slipping.	Remove debris. Add oil Reduce load to machine or adjust slip clutch.
Gearbox overheating	Low oil level. Hard soil.	Add oil. Reduce ground speed.
Blades wear frequently	Muddy or sandy soil.	Reduce ground speed.
Blades break frequently	Stony soil.	Reduce ground speed.
Oil leaking from gearbox/transmission case	Gearbox/transmission case Overfilled. Loose filling/drain plug. Damaged breather plug.	Drain to the proper level. Tighten filling/drain plug. Replace breather plug.

	Damaged seals.	Replace seals.
Implement depth Insufficient	The implement is carried by a tractor. Tractor has insufficient power. Skids need adjusting. Blades worn or bent. Blades incorrectly installed. Debris entangled in blades And/or rotor.	Lower tractor 3-point arms. Increase PTO speed Adjust skids. Replace blades. Install tines correctly. Clear rotor and/or blades
Soil texture too coarse	Tail flap too high. PTO speed too slowly. Ground speed too fast.	Lower tail flap. Increase PTO speed. Reduce ground speed.
Soil texture too fine	Tail flap too low. Ground speed too slow.	Raise tail flap Increase ground speed.
Implement choking up with soil	Blades worn or bent. Blades incorrectly installed. Tail flap too low. Soil too wet.	Replace blades. Install tines correctly. Raise tail flap. Wait until the soil dries.
Implement 'skipping' on the ground or leaving crop residue	Blades incorrectly installed (wrong helical arrangement, cutting edge in the wrong Direction...) Debris entangled in blades And/or rotor. Ground speed too fast. Soil too hard.	Install blades correctly (replace right helical arrangement, position cutting edge in front of rotation direction...) Clear rotor and/or blades. Reduce ground speed. Reduce ground speed and make tilling in more steps.
Soil not uniform	Blades worn or damaged. Skids not aligned. Left side not levelled with the right side.	Replace blades. Align skids. Adjust tractor 3-point arms.
Tractor struggling (under too much load)	Excessive working depth. Excessive PTO speed.	Lower skids. Reduce PTO speed.

SECTION – 8 TORQUE TABLE

Check frequently Rotary Hoe hardware to make sure that screws and bolts are tightened according to torque values listed in the following table:

BOLT SIZE (METRIC)	8.8 grade		10.9 grade	
	N m	Ft lb	N m	Ft lb
M6	11	8	15	11
M8	26	19	36	27
M10	52	39	72	53
M12	91	67	125	93
M14	145	105	200	150
M16	225	165	315	230
M18	310	230	405	300
M20	440	325	610	450

SECTION – 9 PARTS IDENTIFICATION WITH CODE

STUB AXLE DRIVE PLATE ASSEMBLY (XEOS SERIES)

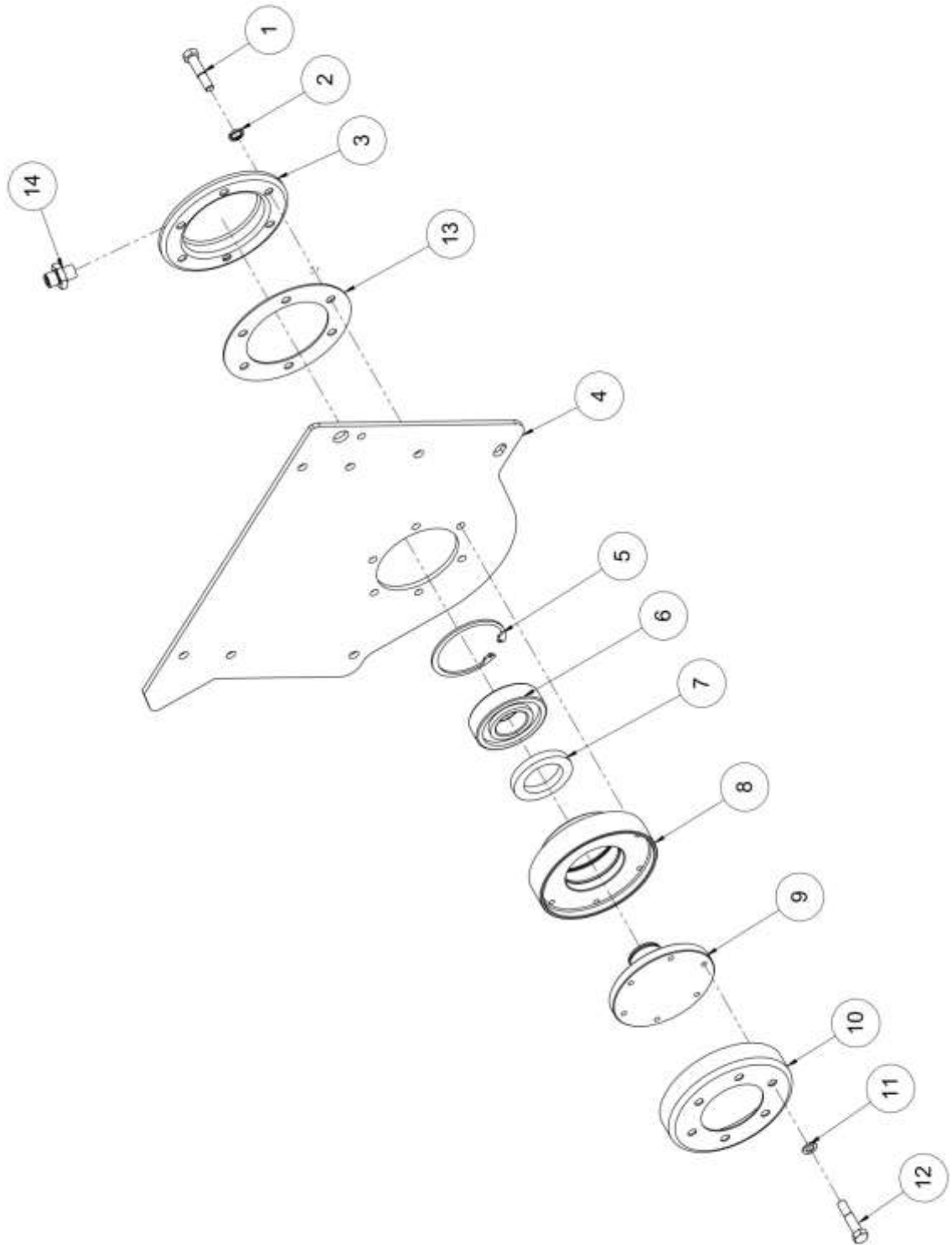

Item	Part Number	Qty	Part Name
1	12010001	6	Hex Bolt M10 x 1.5 x 30
2	12010002	6	Spring Washer 10 M
3	12010003	1	Stub Axle Cover
4	12010004	1	Stub Axle Drive Plate
5	12010005	1	Circlip 95 MM
6	12010006	1	Bearing 6308
7	12010007	1	Oil Seal 50 x 75 x10
8	12010008	1	Stub Axle Housing
9	12010009	1	Stub Axle Shaft
10	12010010	1	Dust Cover
11	12010011	6	Plain Washer 10 MM
12	12010012	6	Hex Bolt M10 x 1.5 x30
13	12010013	1	Gasket
14	12010014	1	Oil Nipple

SIDE DRIVE TRANSMISSION ASSEMBLY (XEOS SERIES)

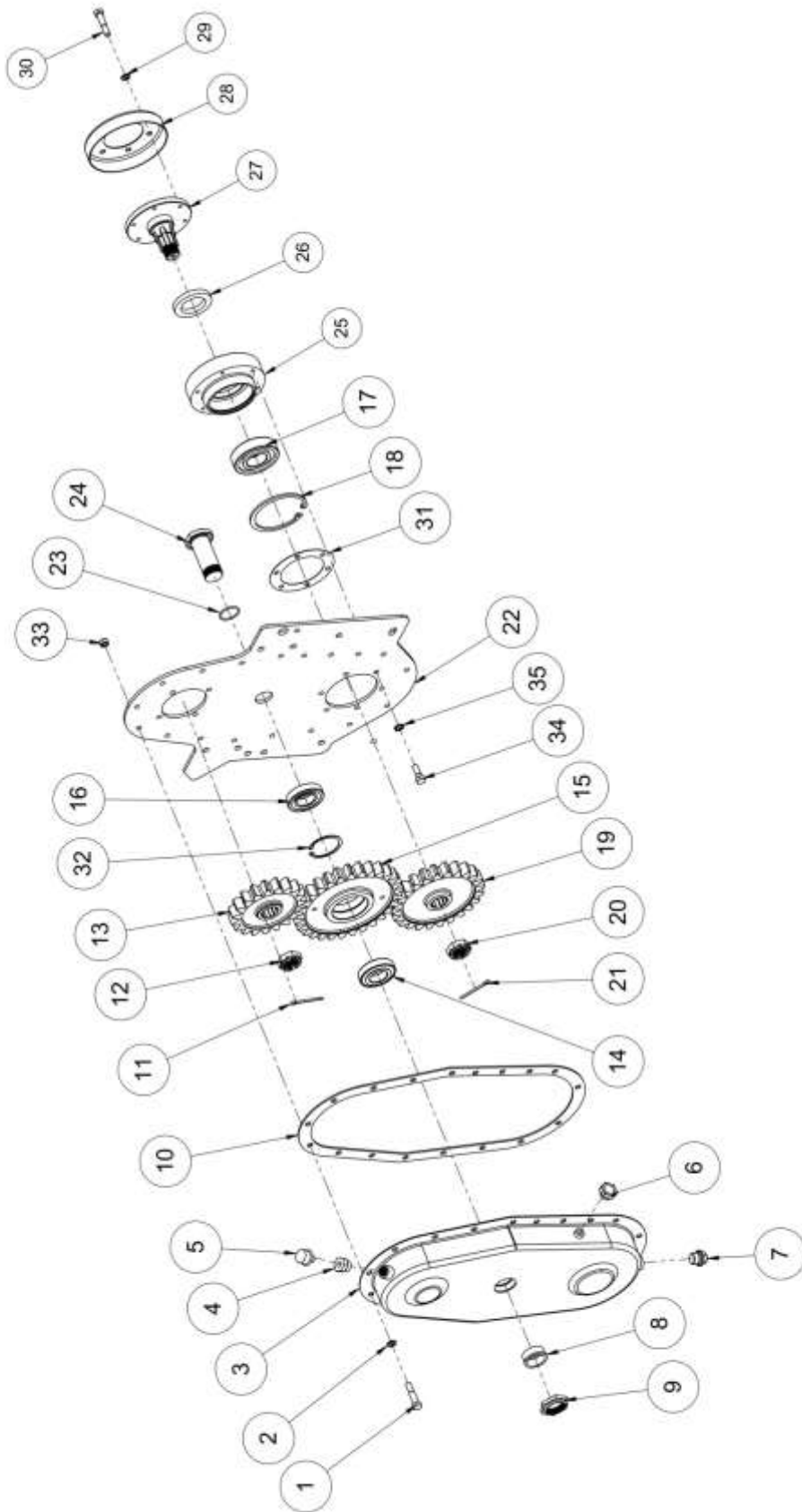

Item	Part Number	Qty	Part Name
1	12020001	20	Hex Bolt M10 x 1.5 x 30
2	12020002	20	Plain Washer – 10 mm
3	12020003	1	Side Drive Transmission Cover
4	12020004	1	Air Breather Threaded Plug
5	12020005	1	Air Breather
6	12020006	1	Oil Level Gauge
7	12020007	1	Oil Drain Out Plug
8	12020008	1	Cover Bush
9	12020009	1	Hex Nut M10 x 1.5 x 30
10	12020010	1	Side Drive Transmission Cover Gasket
11	12020011	1	Cotter Pin
12	12020012	1	Castle Nut
13	12020013	1	19 Teeth Spur Gear
14	12020014	1	Bearing 30207
15	12020015	1	29 Teeth Spur Gear
16	12020016	1	Bearing 30207
17	12020017	1	Bearing 6308
18	12020018	1	Circlip 95 MM
19	12020019	1	24 Teeth Spur Gear
20	12020020	1	Castle Nut
21	12020021	1	Cotter Pin
22	12020022	1	Side Drive Transmission Plate
23	12020023	1	O Ring 34 MM
24	12020024	1	Idle Pin
25	12020025	1	RD Axle Housing
26	12020026	1	Oil Seal 50 x 75 x 10
27	12020027	1	R D Axle Shaft
28	12020028	1	Dust Cover
29	12020029	6	Plain Washer 10 MM
30	12020030	6	Hex Bolt M10 x 1.5 x 30
31	12020031	1	RD Axle Housing Gasket
32	12020032	1	Circlip
33	12020033	20	Nylock Nut 10 MM
34	12020034	6	Hex Bolt M10X 1.5 x30
35	12020035	6	Spring Washer 10 MM

GEAR BOX ASSEMBLY (XEOS SERIES)

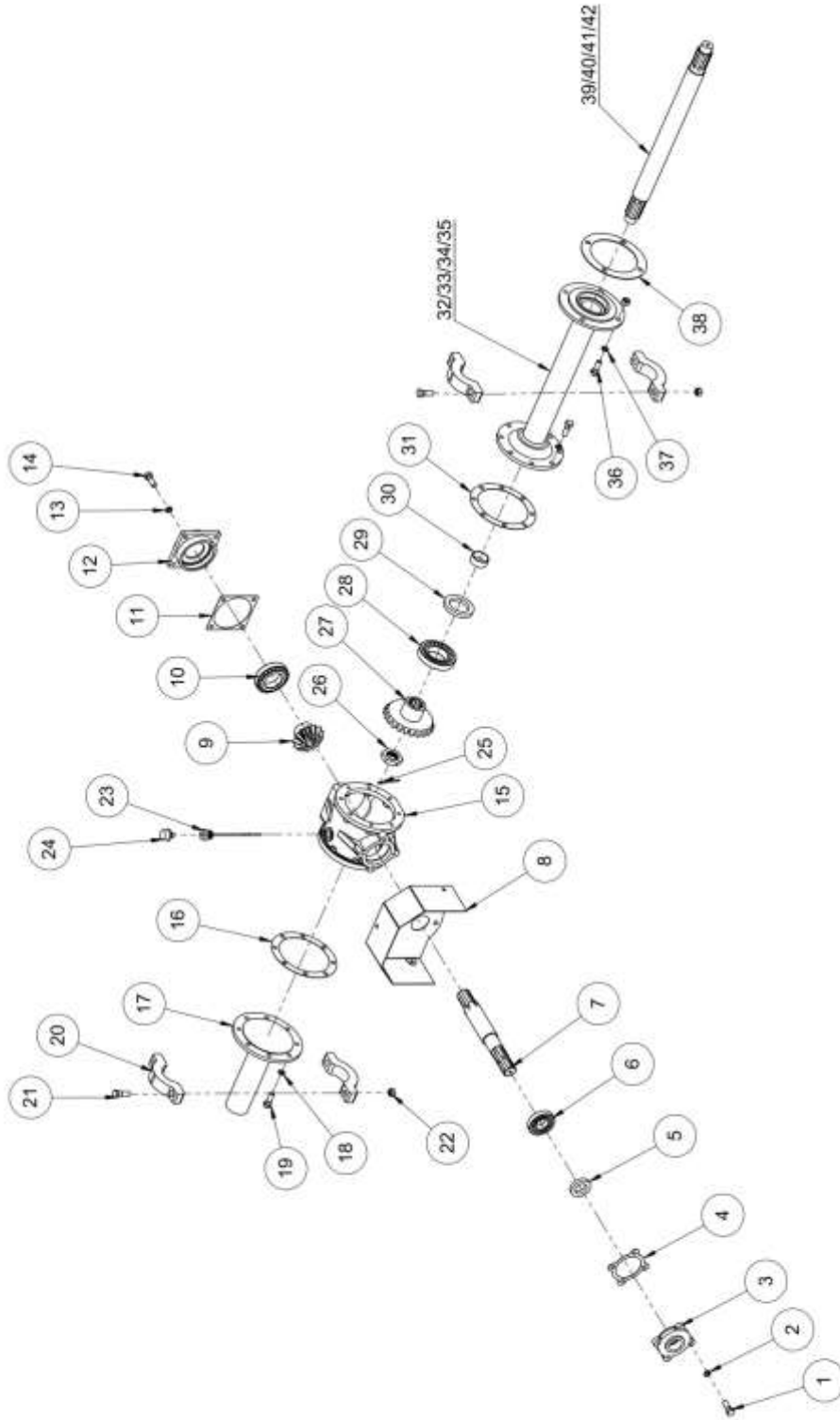

Item	Part Number	Qty	Part Name
1	12030001	2	Hex Bolt M10 x 1.5 x 25
2	12030002	2	Spring Washer 10 MM
3	12030003	1	Gear Box Front Cover
4	12030004	1	Gear Box Front Cover Gasket
5	12030005	1	Oil Seal 35 x 72 x 10
6	12030006	1	Bearing 30207
7	12030007	1	Input Shaft (XE/XP SERIES)
8	12030008	1	PTO Safety Cover (XE/XP SERIES)
9	12030009	1	13 Teeth Pinion (XE/XP SERIES)
10	12030010	1	Bearing 30209
11	12030011	1	Back Cover Gasket (XE/XP SERIES)
12	12030012	1	Gear Box Back Cover (XE/XP Series)
13	12030013	4	Spring Washer 10 MM
14	12030014	4	Hex Bolt M10 x 1.5 x 25
15	12030015	1	Gear Box Housing (XE/XP Series)
16	12030016	1	Gear Box Gasket (XE/XP Series)
17	12030017	1	Gear Side Support Pipe (XE Series)
18	12030018	8	Spring Washer 10 MM
19	12030019	8	Hex Bolt M10 x 1.5 x 25
20	12030020	2	Side Support Pipe Clamp
21	12030021	4	Hex Bolt M10 x 1.5 x 35
22	12030022	4	Nylock Nut 10 MM
23	12030023	1	Oil Level Plug
24	12030024	1	Air Breather
25	12030025	1	Cotter Pin
26	12030026	1	Castle Nut
27	12030027	1	23 Teeth Crown
28	12030028	1	Bearing 30210
29	12030029	1	Oil Seal 50 x 75 x 10
30	12030030	1	Spacer
31	12030031	1	Jack Shaft Housing Gasket
32	12030032	1	Jack Shaft Housing Pipe (XE36)
33	12030033	1	Jack Shaft Housing Pipe (XE42)
34	12030034	1	Jack Shaft Housing Pipe (XE48)
35	12030035	1	Jack Shaft Housing Pipe (XE60)
36	12030036	4	Hex Bolt M10 x 1.5 x 35
37	12030037	4	Nylock Nut 10 MM
38	12030038	1	Jack Shaft Housing Pipe Gasket
39	12030039	1	Jack Shaft (XE36)
40	12030040	1	Jack Shaft (XE42)
41	12030041	1	Jack Shaft (XE48)
42	12030042	1	Jack Shaft (XE60)

ROTOR ASSEMBLY (XEOS SERIES)

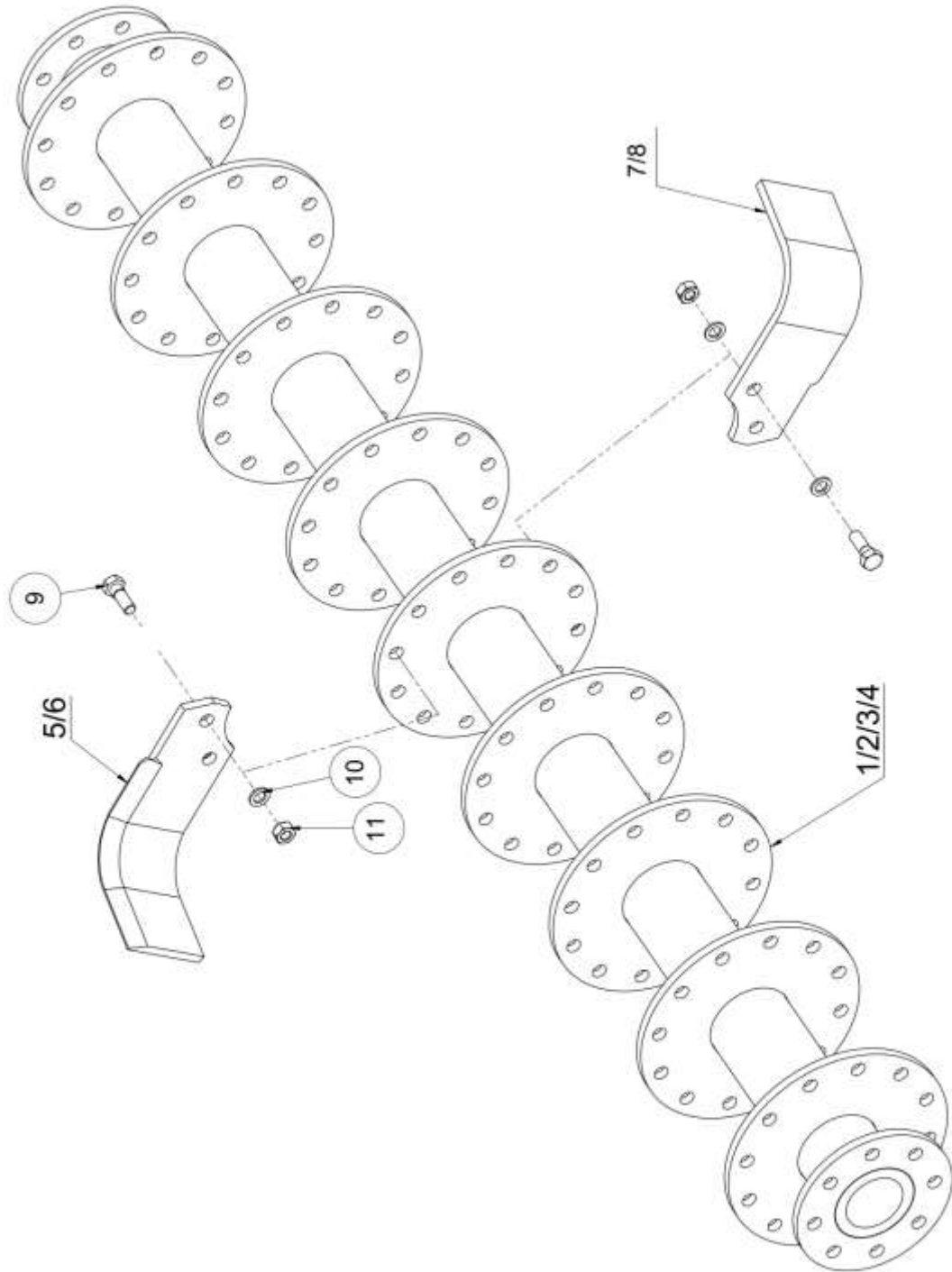

Item	Part Number	Qty	Part Name
1	12040001	1	24 Blade Rotor – Without Blade (XE36)
2	12040002	1	30 Blade Rotor – Without Blade (XE42)
3	12040003	1	36 Blade Rotor – Without Blade (XE48)
4	12040004	1	42 Blade Rotor – Without Blade (XE60)
5	12040005	1	RH Blade – L/Square Type (60 mm x 6 mm)
6	12040006	1	RH Blade – L/Curved Type (60 mm x 6 mm)
7	12040007	1	LH Blade – L/Square Type (60 mm x 6 mm)
8	12040008	1	LH Blade – L/Curved Type (60 mm x 6 mm)
9	12040013	10 **	Hex Bolt M 12 x 1.75 x 35
10	12040014	10 **	Spring Washer 12 MM
11	12040015	10 **	Nylock Nut 12 MM

HULL ASSEMBLY (XEOS SERIES)

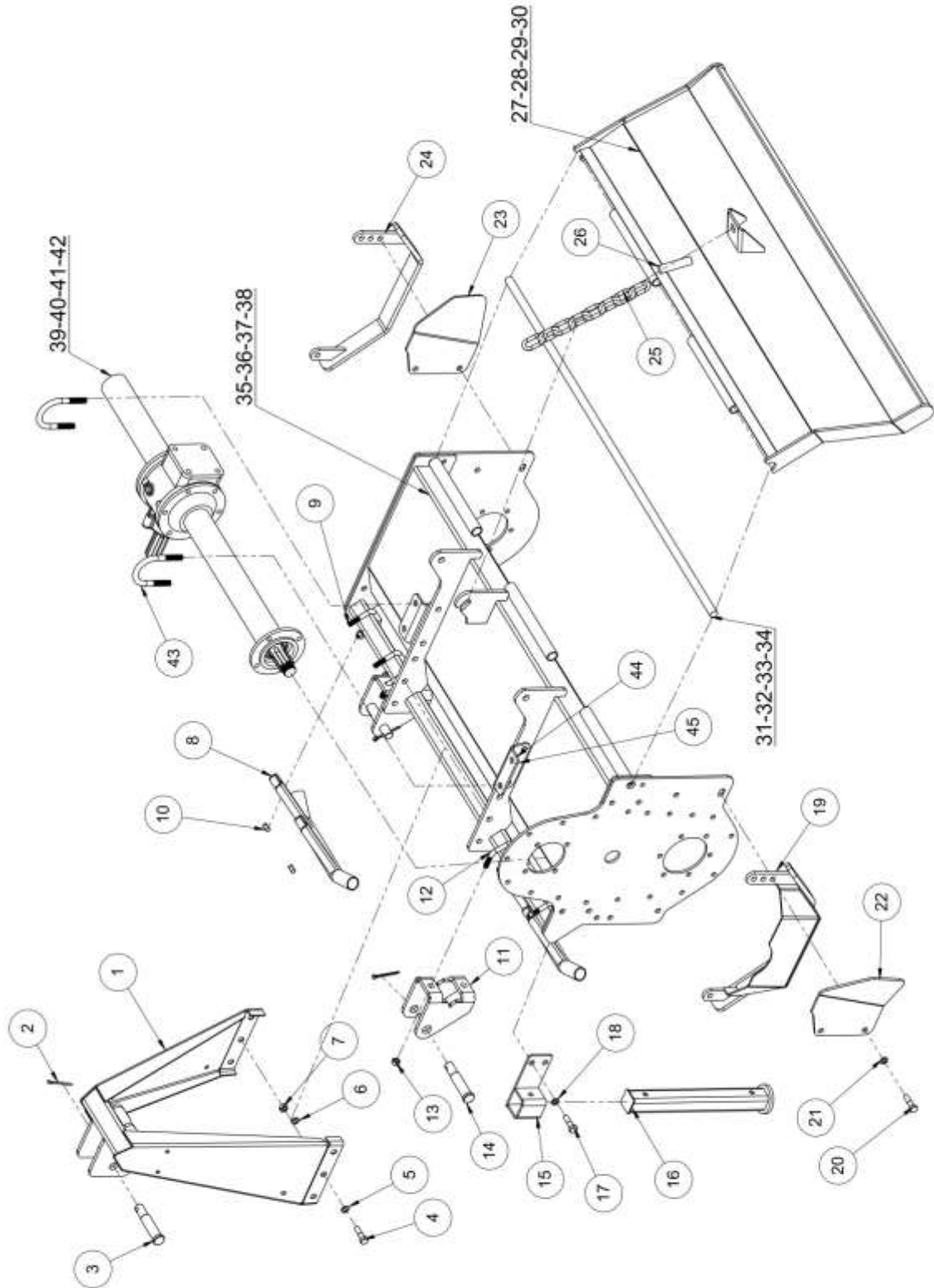

Item	Part Number	Qty	Part Name
1	12050001	1	Top Mast Component
2	12050002	3	Cotter Pin
3	12050003	1	Upper Hitch Pin
4	12050004	10	Hex Bolt M12 x 1.75 x 35
5	12050005	10	Plain Washer 12 MM
6	12050006	10	Spring Washer 12 MM
7	12050007	10	Nylock Nut 12 MM
8	12050008	2	Rotor Safety Guard
9	12050009	4	Rotor Safety Guard U Clamp
10	12050010	8	Nylock Nut 10 MM
11	12050011	2	Lower Hitch Point Bracket
12	12050012	8	U Clamp
13	12050013	8	Nylock Nut 10 MM
14	12050014	2	Lower Hitch Point Pin
15	12050015	1	Rotary Hoe Parking Stand Bracket
16	12050016	1	Stand Pipe
17	12050017	2	Hex Bolt M10 x 1.5 x 30
18	12050018	2	Spring Washer 10 MM
19	12050019	1	Depth Skid – LH Side
20	12050020	4	Hex Bolt 12 x 1.75 x 40
21	12050023	4	Plain Washer 12 MM
22	12050024	1	Guard Plate – LH
23	12050025	1	Guard Plate – RH
24	12050026	1	Depth Skid – RH Side
25	12050027	1	Lifting Chain
26	12050028	1	Lifting Chain Spring
27	12050029	1	Trailing Board (XE36)
28	12050030	1	Trailing Board (XE42)
29	12050031	1	Trailing Board (XE48)
30	12050032	1	Trailing Board (XE60)
31	12050033	1	Trailing Board Rod (XE36)
32	12050034	1	Trailing Board Rod (XE42)
33	12050035	1	Trailing Board Rod (XE48)
34	12050036	1	Trailing Board Rod (XE60)
35	12050037	1	Hull (XE36)
36	12050038	1	Hull (XE42)
37	12050039	1	Hull (XE48)
38	12050040	1	Hull (XE60)
39	12050041	1	Side Support Pipe (XE36)
40	12050042	1	Side Support Pipe (XE42)
41	12050043	1	Side Support Pipe (XE48)
42	12050044	1	Side Support Pipe (XE60)
43	12050045	2	U Clamp
44	12050046	2	Bottom Jack/Support Pipe Bracket
45	12050047	4	Nylock Nut 10 MM

SECTION – 10 WARRANTY

GANESH AGRO EQUIPMENTS warrants to the original purchaser that this product will be free from defects in material and workmanship beginning on the date of purchase by the end user according to the following schedule when used as intended and under normal service and conditions for personal use.

Overall Unit and Driveline: 2 year Parts

PTO Joint : Warranty Not applicable (Except Manufacturing defect)

Blade: Warranty Not applicable (Except Manufacturing Defect)

Paint : Warranty Not applicable (Except Manufacturing Defect)

Gearbox: 2 years Parts

This Warranty is limited to the replacement of any defective part by GANESH AGRO EQUIPMENTS and the installation by the dealer of any such replacement part, and does not cover common wear items. GANESH AGRO EQUIPMENTS reserves the right to inspect any equipment or parts which are claimed to have been defective in material or workmanship.

This Warranty does not apply to any part or product which in GANESH AGRO EQUIPMENT'S judgment shall have been misused or damaged by accident or lack of normal maintenance or care, or which has been repaired or altered in a way which adversely affects its performance or reliability, or which has been used for a purpose for which the product is not designed. Misuse also specifically includes failure to properly maintain oil levels, grease points, and driveline shafts. Claims under this Warranty should be made to the dealer/company which originally sold the product and all warranty adjustments must be made through an authorized GANESH AGRO EQUIPMENTS'S dealer. GANESH AGRO EQUIPMENTS reserves the right to make changes in materials or design of the product at any time without notice. This Warranty shall not be interpreted to render GANESH AGRO EQUIPMENTS liable for damages of any kind, direct, consequential, or contingent to property. Furthermore, GANESH AGRO EQUIPMENTS shall not be liable for damages resulting from any cause beyond its reasonable control. This Warranty does not extend to loss of crops, any expense or loss for labor, supplies, rental machinery or for any other reason.

No other warranty of any kind whatsoever, express or implied, is made with respect to this sale; and all implied warranties of merchantability and fitness for a particular purpose which exceed the obligations set forth in this written warranty are hereby disclaimed and excluded from this sale. This Warranty is not valid unless end user are not registered with GANESH AGRO EQUIPMENTS within 30 days from the date of purchase by the end user.

Seal & Sign –

Date –

Place - Vadpura